

Parça Part	Açıklama Description	Ölçüler Dimensions
#	#	mm
JP64	7 Dişi Portlu Dağıtıcı 7 Female Port - 178mm	
JP65	7 Dişi Portlu Dağıtıcı 7 Female Port - 370mm	
JP66	6 Dişi Portlu Dağıtıcı 6 Port Hexagon Type	
VB201	Kısıcı Vanalı 2'li Dağıtıcı 2 Way Manifold	
VB401	Kısıcı Vanalı 4'lü Dağıtıcı 4 Way Manifold	
BV42	Pilot Check Valve	
BV110	Yük İndirme Valfi Load Lowering Valve	
VH33	Hat Tipi Check Valf Non-Return Valve	

Manometre Adaptörleri Gauge Adapters







Parça Part	Ölçüler Dimensions
#	mm
PGA701	
E0567	

Parça Part	Ölçüler Dimensions
#	mm
E1336	
E1343	

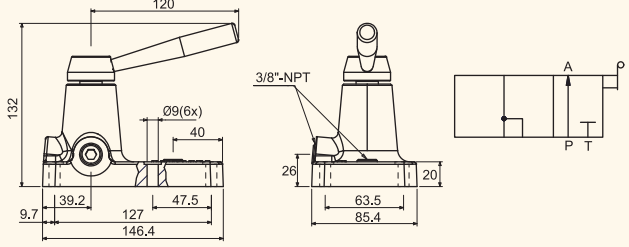
Maximum Working Pressure
700 Bar / 10.000 Psi

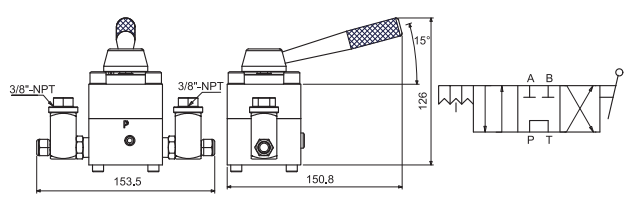
Parça Part	Açıklama Description	Ölçüler Dimensions
#	#	mm
VC331	İğneli Kısıcı Vana Needle Valve	
VB66	Manuel Çek Valf Manual Check Valve Auto Overload Design	
VB101	İğneli Kısıcı Vana (3/8NPT) Needle Valve No Auto Overload Design	
VB102	İğneli Kısıcı Vana (1/4NPT) Needle Valve No Auto Overload Design	
BG9623	Basınç Tahliye Valfi Inline Pressure Relief Valve	
PRV9633	Basınç Ayar Valfi Inline Pressure Regulator	

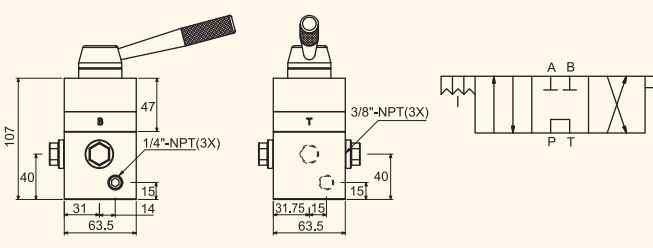
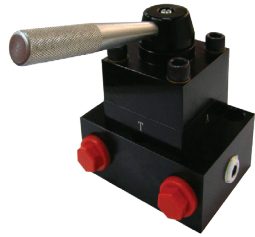
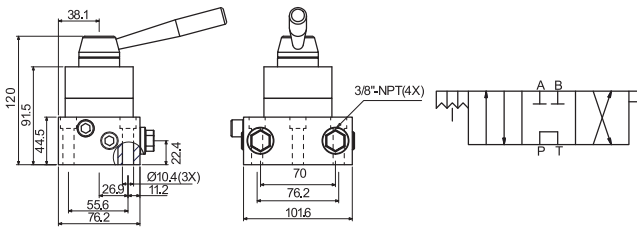
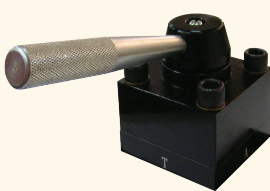
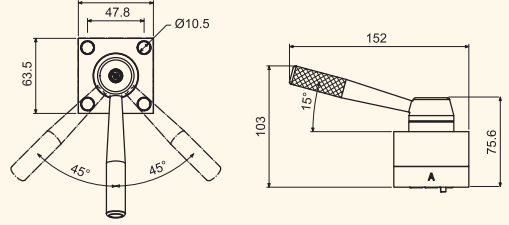

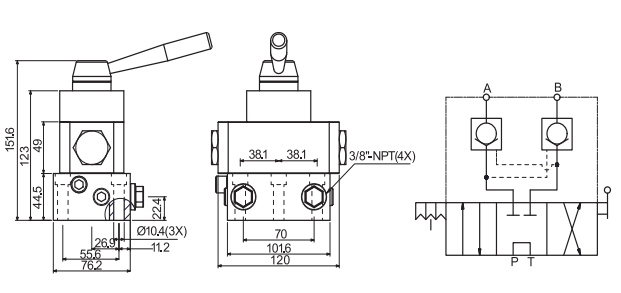
Parça Part	Açıklama Description	Ölçüler Dimensions
#	#	mm
BP2	3 Yollu 2 Konumlu Valf Advance/Retract	 
BP421	4 Yollu 3 Konumlu Valf Advance/Hold/Retract	 
BP422	4 Yollu 3 Konumlu Valf Advance/Hold/Retract	 
BP423	4 Yollu 3 Konumlu Valf Advance/Hold/Retract HP80D, AP13D, AP18D EP13D, EP18D, EP21D EP320D, EP420D	 
BP42R	4 Yollu 3 Konumlu Valf Advance/Hold/Retract BP423'ün üst kısmı	 
BP425	4 Yollu 3 Konumlu Valf +Yük Tutma Özelliği Advance/Hold/Retract	 

Parça Part	Açıklama Description	Ölçüler Dimensions
#	#	mm
BP426	4 Yollu 3 Konumlu Valf Advance/Hold/Retract HP35D	
BP427	4 Yollu 3 Konumlu Valf +Yük Tutma Özelliği Advance/Hold/Retract	
BP430	4/3 Kapalı Merkez Valf 4/3 Valve Closed Center	
BP432	4/3 Kapalı Merkez Valf 4/3 Valve Closed Center	
SV32	3/2 Solenoid Valf Tek Etkili / Single Acting 24V / 110V / 220V	
SV43	4/3 Solenoid Valf Çift Etkili / Double Acting 24V / 110V / 220V	

Maximum Working Pressure
700 Bar / 10.000 Psi

Parça Part	Açıklama Description	Ölçüler Dimensions
#	#	mm
ADL202	Dirsek Elbow	
ADL303	Dirsek Elbow	
ADC303	Dirsek Elbow	
ADE303	Dirsek Elbow	
ADT202	Tee Adaptör	
ADT303	Tee Adaptör	
ADG303	Tee Adaptör	
ADG323	Tee Adaptör	
ADF203	Adaptör	
ADF203	Adaptör	

Parça Part	Açıklama Description	Ölçüler Dimensions
#	#	mm
ADF303	Adaptör	
ADF304	Adaptör	
ADI202	Manşon Connector	
ADI203	Manşon Connector	
ADI303	Manşon Connector	
ADO202	Hexagon Nippel	
ADO2031	Hexagon Nippel	
ADO203	Hexagon Nippel	
ADO303	Hexagon Nippel	
BG9705	Swivel Connector	