

This document must not be copied, either completely or in part, without permission. Any infringement will have legal consequences ©

A3

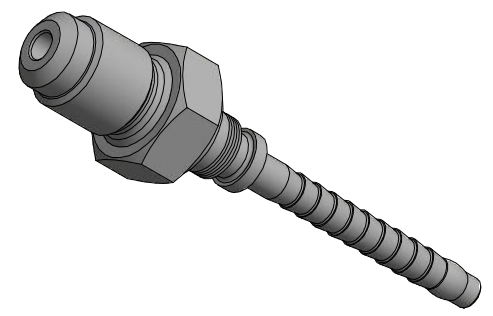

1 : 1

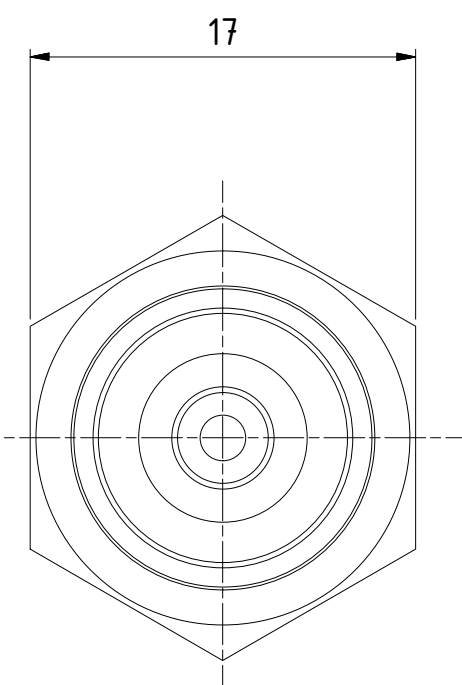
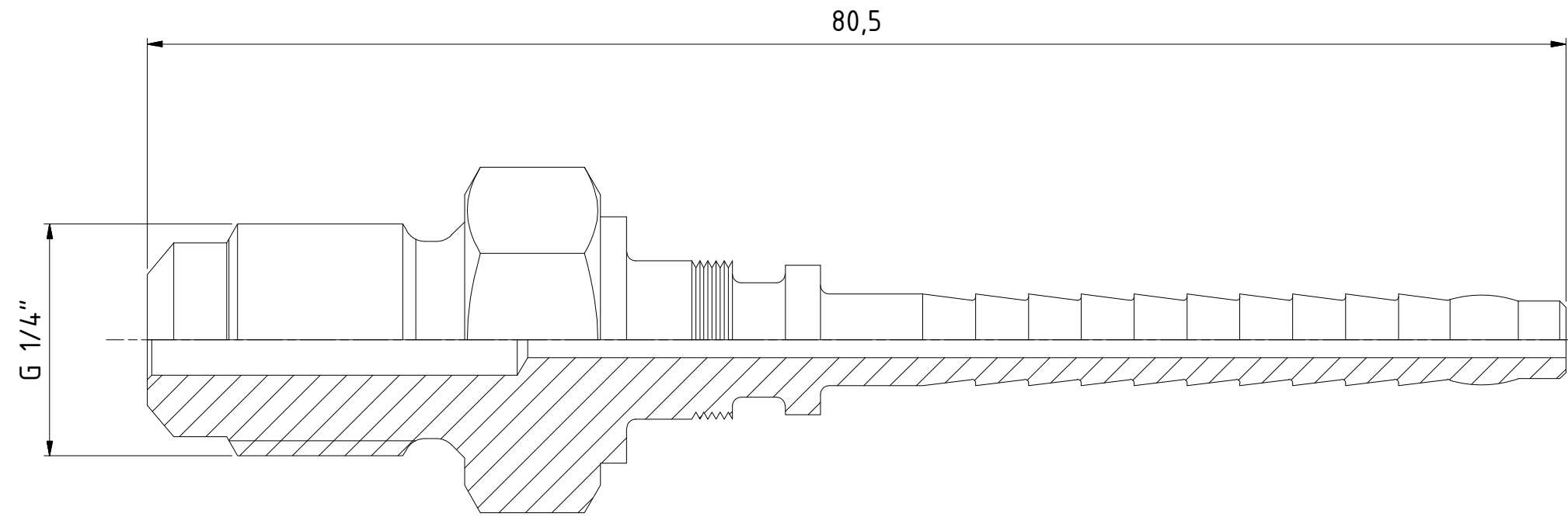

Scale	3 : 1	Drawn	CABANLA	Checked	CABEP07	Appr.	CABJW	ECO	Date	2017-11-06
Drawing No.								Issue	Sheet	
Assembly Drawing								199512530	AA	1 / (1)