



Torque/Pressure Chart

Pump Pressure (P.S.I.)	Tool Output (FT./LBS.)
1000	330
1200	395
1400	460
1600	525
1800	590
2000	655
2200	722
2400	789
2600	856
2800	923
3000	990
3200	1,058
3400	1,126
3600	1,194
3800	1,262
4000	1,330
4200	1,397
4400	1,464
4600	1,531
4800	1,599
5000	1,667
5200	1,734
5400	1,802
5600	1,870
5800	1,938
6000	2,006



THE SHAPE CHANGER

SQ SQUARE DRIVE TORQUE WRENCH

SQ

UNI-SWIVEL SQUARE DRIVE HYDRAULIC TORQUE WRENCH THE WRENCH WITH CURVES

THE HYDRAULIC WRENCH WITH A SHAPE LIKE NO OTHER ... FOR A REASON! EVERY ANGLE. EVERY CURVE. EVERY FEATURE ON THE SQ SERIES IS DESIGNED WITH A PURPOSE. FROM A BLANK SHEET OF PAPER, WE TOOK 20 YEARS OF HYDRAULIC WRENCH KNOWLEDGE AND CREATED A WRENCH WITH A SHAPE WHICH IS UNIQUELY TORCUP. WITHIN THE BEAUTY OF THE SQ IS THE STRONGEST AND LONGEST TROUBLE-FREE OPERATING MECHANISM DESIGNED. THE PURPOSELY ENGINEERED THREE MOVING PARTS WITHIN THE SQ ARE THE RESULT OF 20 YEARS OF ON-SITE APPLICATION KNOWLEDGE. THE COMBINATION OF THE HIGHEST GRADE AEROSPACE ALLOYS AND FUTURISTIC MACHINING TECHNIQUES CREATE AN OUTPUT EFFICIENCY GREATER THAN ANY OTHER WRENCH ON THE MARKET. SIMPLY PUT...THERE IS NO COMPARISON TO THE SQ SERIES HYDRAULIC TORQUE WRENCH.



THE POWER INSIDE

1. PATENTED MONO-BODY HOUSING
2. BALANCED DRIVE ROD
3. MULTI-TOOTH DRIVE SEGMENT
4. ANTI-BACK LASH MECHANISM
5. LASER ENGRAVED TORQUE CHART
6. MULTI-TOOTH RATCHET
7. ONE PIECE DRIVE PLATE
8. PUSH-THROUGH DRIVE
9. SINGLE SEAL PISTON
10. DIRECT HOUSING REACTION
11. STEEL REACTION BOOT
12. LONG LENGTH REACTION ARM
13. REACTION ARM THUMB RELEASE BUTTON
14. QUICK CONNECT NO-DRIP COUPLERS
15. 180° X 360° SINGLE SWIVEL MOVEMENT

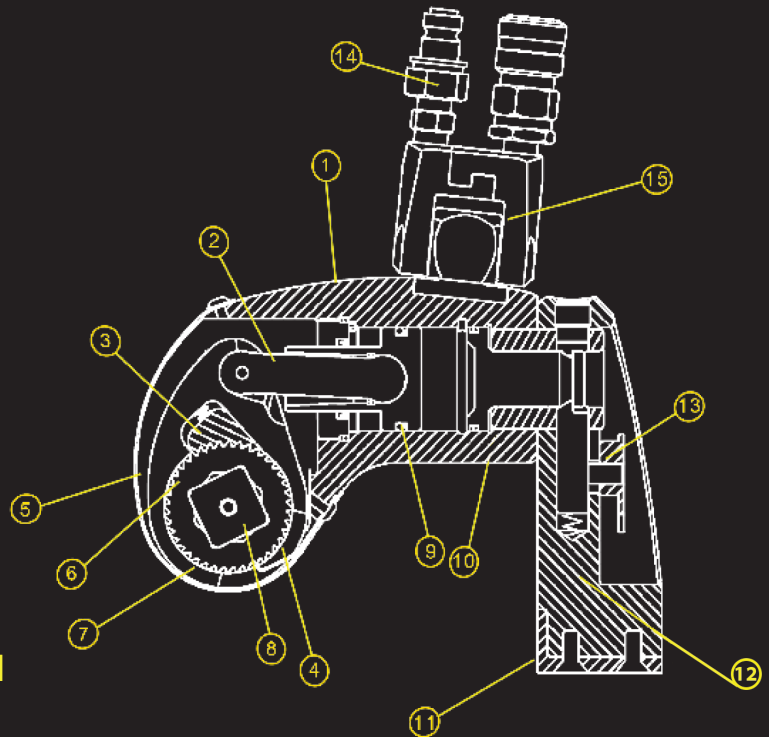

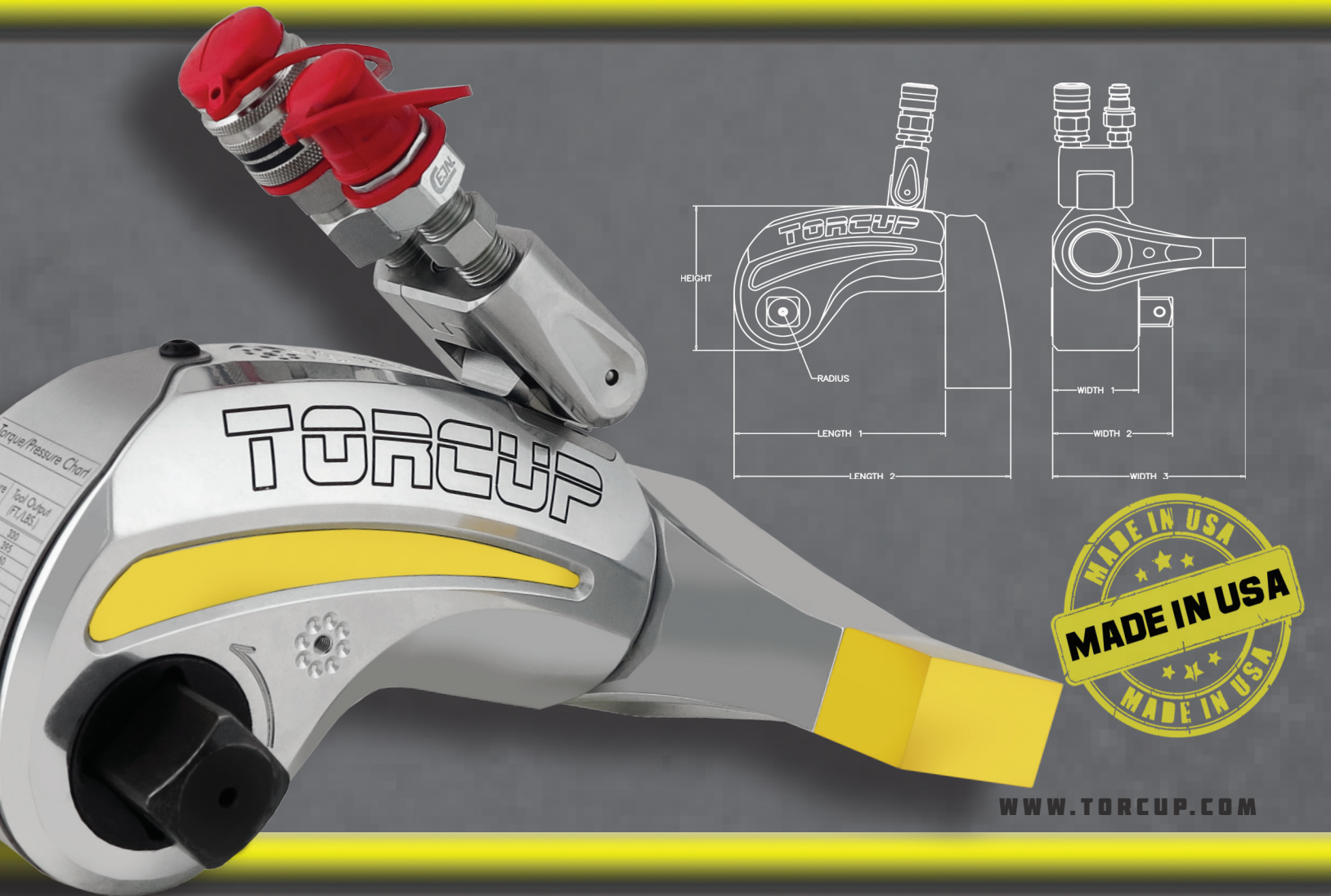

POWER ENGINEERED

MODEL NUMBER	SQ-1	SQ-3	SQ-5	SQ-10
SQUARE DRIVE	3/4"	1"	1 1/2"	1 1/2"
MIN. TORQUE (ft/lbs)	132	292	587	1198
MAX. TORQUE (ft/lbs)	1345	3425	5922	11908
MIN. TORQUE (nm)	179	396	796	1624
MAX. TORQUE (nm)	1824	4644	8029	16145
OUTPUT ACCURACY	+/-3%	+/-3%	+/-3%	+/-3%
REPEATABILITY	100%	100%	100%	100%
DUTY CYCLE	100%	100%	100%	100%
TOOL WEIGHT (lbs)	5.5	11.0	18.5	32.0
TOOL WEIGHT (kgs)	2.5	5.0	8.4	14.5
HEIGHT (in)	3.76	4.91	6.05	7.34
HEIGHT (mm)	95.5	124.7	153.6	186.4
LENGTH 1 (in)	4.91	6.48	7.95	9.85
LENGTH 1 (mm)	124.7	164.5	201.9	250.1
LENGTH 2 (in)	6.47	8.48	10.70	2.85
LENGTH 2 (mm)	164.3	215.3	271.7	326.3
RADIUS (in)	0.99	1.31	1.57	2.13
RADIUS (mm)	25.1	33.2	39.8	54.1
WIDTH 1 (in)	2.0	2.63	3.13	3.95
WIDTH 1 (mm)	50.8	66.8	79.5	100.3
WIDTH 2 (in)	2.75	3.68	4.64	5.47
WIDTH 2 (mm)	69.8	93.5	117.8	138.9
WIDTH 3 (in)	4.61	5.92	7.0	8.74
WIDTH 3 (mm)	117.0	150.3	177.8	222.0



SQ SERIES UNI-SWIVEL
SQUARE DRIVE
HYDRAULIC TORQUE WRENCH

UNIQUE - THE SHAPE THAT FITS
ENDURING - 20 YEARS OF ENGINEERING
ADAPTABLE - ACCESSORIES FOR EVERYWHERE

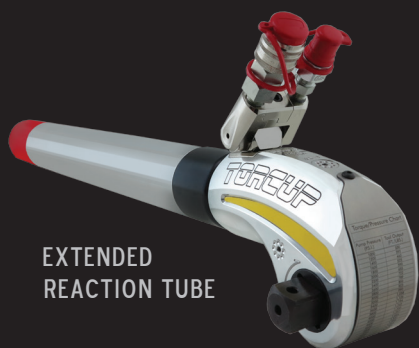

EXTENDED
REACTION TUBE



DIRECT HEX
ADAPTOR



END CAP
PROTECTOR



TOOL
HANDLE



NON PUSH THRU
SQUARE DRIVE



WIDE BOOT
REACTION ARM

SQ SERIES

Made In USA

Only Three Moving Parts

Every Unit Calibrated In Our
ISO17025 Laboratory

Manufactured With AQ
Certified Alloys

Uni-Swivel Hose Maneuverability

Genuine TorcUP Design



Worldwide Headquarters

1025 Conroy Place

Easton, PA 18040 USA

TOLL FREE: 1-888-TorcUP-1

TELEPHONE: 1-610-250-5800

FAX: 1-610-250-2700

www.torcup.com



CARRYING
CASE



Catalog 2017